



Scout™

Sonde and Line Locator



Scout™ Sonde and Line Locator	
Record Serial Number below and retain product serial number which is located on nameplate.	
Serial No.	

Table of Contents

Recording Form for Machine Model and Serial Number	1
General Safety Information	
Work Area Safety	2
Electrical Safety	2
Battery Precautions.....	2
Personal Safety	2
Scout Use and care.....	2
Service	3
Specific Safety Information	
Important Notice.....	3
Specifications and Standard Equipment	
Specifications	3
Standard Equipment	4
Icon Legend	4
Introduction to the Scout	
What Are Its Unique Features?	4
What Does It Do?	4
What Is The Scout Advantage?	
The Micro Map Advantage	5
Scout Components	5
Display Screen	6
Keypad	7
Getting Started	
Installing/Changing Batteries	7
Operation Time	7
Powering Up and Down	8
Low Battery Warning.....	8
Set Up	8
Menu Choices	9
Sounds of the Scout.....	9
Tools Menu	
Change of Depth Units.....	9
Auto Back Light.....	9
LCD Contrast	10
Locating the Sonde	
Verifying the Locate	11
Measuring Depth.....	11
Operating Tips for Locating a Sonde	12
Micro Map – Examples – Sonde Mode	13
Tilted Sondes	14
Tracing a Line with Scout	
Tracing a Passive AC Line	14
Operating Tips for Line Tracing.....	15
Micro Map – Example – Line Trace	15
Notes on Accuracy	
Noise	16
Locating Is Not An Exact Science	16
Locating Faulty Components	16
Service and Repair	16
Troubleshooting Guide	17
Appendix A	18
Understanding Sondes and The Scout	18-19
Appendix B	20
Other Useful Information	20
Lifetime Warranty	Back Cover

General Safety Information

WARNING! Read and understand all instructions. Failure to follow all instructions listed below may result in electric shock, fire, and/or serious personal injury.



SAVE THESE INSTRUCTIONS!

Work Area Safety

- **Keep your work area clean and well lit.** Cluttered benches and dark areas may cause accidents.
- **Do not operate electrical devices or power tools in explosive atmospheres, such as in the presence of flammable liquids, gases, or heavy dust.** Electrical devices or power tools create sparks which may ignite the dust or fumes.
- **Keep bystanders, children, and visitors away while operating tool.** Distractions can cause you to lose control.

Electrical Safety

- **Do not operate the system with electrical components removed.** Exposure to internal parts increases the risk of injury.
- **Avoid exposure to rain or wet conditions.** Keep battery out of direct contact with water. Water entering electrical devices increases the risk of electric shock.
- **Do not probe high voltage line.**

Battery Precautions

- **Use only the size and type of battery specified. Do not mix cell types (e.g. do not use alkaline with rechargeable).** Do not use partly discharged and fully charged cells together (e.g. do not mix old and new).
- **Recharge batteries with charging units specified by the battery manufacturer.** Using an improper charger can overheat and rupture the battery.
- **Properly dispose of the batteries.** Exposure to high temperatures can cause the battery to explode, so do not dispose of in a fire. Some countries have regulations concerning battery disposal. Please follow all applicable regulations.

Personal Safety

- **Stay alert, watch what you are doing and use common sense.** Do not use diagnostic tool while tired or under the influence of drugs, alcohol, or medications. A moment of inattention while operating tools may result in serious personal injury.
- **Gloves should always be worn for health and safe-**

ty reasons. Sewer lines are unsanitary and may contain harmful bacteria and viruses.

- **Do not overreach. Keep proper footing and balance at all times.** Proper footing and balance enables better control of the tool in unexpected situations.
- **Use safety equipment.** Always wear eye protection. Dust mask, non-skid safety shoes, hard hat, or hearing protection must be used for appropriate conditions.
- **Use proper accessories.** Do not place this product on any unstable cart or surface. The product may fall causing serious injury to a child or adult or serious damage to the product.
- **Prevent object and liquid entry.** Never spill liquid of any kind on the product. Liquid increases the risk of electrical shock and damage to the product.
- **Avoid Traffic. Pay close attention to moving vehicles when using on or near roadways. Wear visible clothing or reflector vests.** Such precautions may prevent serious injury.

Scout Use and Care

- **Use equipment only as directed.** Do not operate the Scout unless proper training has been completed and the owners manual read.
- **Do not immerse the antennas in water. Store in a dry place.** Such measures reduce the risk of electric shock and instrument damage.
- **Store idle equipment out of the reach of children and other untrained persons.** Equipment is dangerous in the hands of untrained users.
- **Maintain the instrument with care.** Properly maintained diagnostic instruments are less likely to cause injury.
- **Check for breakage of parts, and any other conditions that may affect the Scout's operation.** If damaged, have the instrument serviced before using. Many accidents are caused by poorly maintained tools.
- **Use only accessories that are recommended by the manufacturer for the Scout.** Accessories that may be suitable for one instrument may become hazardous when used on another.
- **Keep handles dry and clean; free from oil and grease.** Allows for better control of the instrument.
- **Protect against excessive heat.** The product should be situated away from heat sources such as radiators, heat registers, stoves or other products (including amplifiers) that produce heat.

Service

- **Diagnostic instrument service must be performed only by qualified repair personnel.** Service or maintenance performed by unqualified repair personnel could result in injury.
- **When servicing a tool, use only identical replacement parts.** Follow instructions in the Maintenance Section of this manual. Use of unauthorized parts or failure to follow maintenance instructions may create a risk of electrical shock or injury.
- **Follow instructions for changing accessories.** Accidents are caused by poorly maintained tools.
- **Provide proper cleaning.** Remove battery before cleaning. Do not use liquid cleaners or aerosol cleaners. Use a damp cloth and some mild detergent. Do not immerse in water.
- **When cleaning, do not use scraping tools or abrasives as they may permanently scratch the display.** NEVER USE SOLVENTS to clean any part of the system. Substances like acetone and other harsh chemicals can cause cracking of the Case.
- **Conduct a safety check.** Upon completion of any service or repair of this product, ask the service technician to perform safety checks to determine that the product is in proper operating condition.
- **Damage to the product that requires service.** Remove the batteries and refer servicing to qualified service personnel under any of the following conditions:
 - If liquid has been spilled or objects have fallen into product;
 - If product does not operate normally by following the operating instructions;
 - If the product has been dropped or damaged in any way;
 - When the product exhibits a distinct change in performance.

If you have any questions regarding the service or repair of this machine, call or write to:

Ridge Tool Company
 Technical Service Department
 400 Clark Street
 Elyria, Ohio 44035-6001
 Tel: (800) 519-3456
 E-mail: TechServices@ridgid.com
 On the Web: www.ridgid.com or
 www.seesnake.com

In any correspondence, please give all the information shown on the nameplate of your tool including model number and serial number.

Specific Safety Information

▲ WARNING

Read this operator’s manual carefully before using the Scout™ Sonde and line Locator. Failure to understand and follow the contents of this manual may result in electrical shock, fire and/or severe personal injury.

Call the Ridge Tool Company, Technical Service Department at (800) 519-3456 if you have any questions.

Important Notice

The Scout is a diagnostic tool that senses electromagnetic fields emitted by objects underground. It is meant to aide the user in locating these objects by recognizing characteristics of the field lines and displaying them on the screen. As electromagnetic field lines can be distorted and interfered with it is important to verify the location of underground objects before digging.

Several utilities may be underground in the same area. Be sure to follow local guidelines and one call service procedures.

Exposing the utility is the only way to verify it’s existence, location and depth.

Ridge Tool Co., its affiliates and suppliers, will not be liable for any injury or any direct, indirect, incidental or consequential damages sustained or incurred by reason of the use of the Scout.

Specifications and Standard Equipment

Specifications

Weight w/batteries.....3 lbs.

Weight w/o batteries.....2.3 lbs.

Dimensions:

Length11.2”

Width4.3”

Height.....22”

Power Source.....4 C-size batteries, 1.5V Alkaline (ANSI/NEDA 14A, IEC LR14) or 1.2V NiMH or NiCad rechargeable batteries

Power Rating:.....6V, 300mA

Operating Environment

Temperature.....-4°F to 122°F (-20°C to 50°C)

Humidity5% to 95% RH

Storage Temperature-4°F to 140°F (-20°C to 60°C)

Standard Frequencies

- Sonde512Hz, 640Hz, 874Hz, 33kHz
- Active Line Trace.....512Hz, 8kHz, 33kHz,
- Passive Line Trace.....60Hz, 50Hz

Default Settings

The default settings for the locator are:

- Depth units = Feet & Inches,
- Volume = 1 (one setting above mute),
- Backlight = Auto

Standard Equipment

- Scout Locator
- Markers and Mast Holder
- Operator's Manual
- 4 C-cell Batteries (Alkaline)
- Training Video

Optional Equipment

- Additional Pole/Sonde Markers
- NaviTrack Transmitter
- Inductive Clamp
- Battery Sonde
- Float Sonde

NOTE:

- 60Hz = 540 Hz, 9th harmonic and 50hz = 450 Hz, 9th harmonic
- Signal Strength is Non linear in function. 2000 is 10x higher than 1000, 3000 is 10x higher then 2000.

Introduction to the Scout

The Scout sonde and line locator uses multi directional antennas and advanced processing to make pinpointing sondes and tracing buried utility lines fast, accurate and easy.

What Are Its Unique Features?

Scout's advanced technology gives several unique features over conventional locators:

- Multi Directional Antenna System
- Micro map View
- Identifies distinct signal characteristics.











What Does It Do?

The Scout is used above ground to sense electromagnetic fields emitted from underground or hidden lines (electrical conductors like metal wires and pipes) or **sondes** (actively transmitting beacons). When the fields are simple and undistorted, then the sensed fields are representative of the buried object. The Scout locates conductive objects emitting a field; it does not directly sense underground objects.

See Appendix A for further discussion on electrical fields.

Icon Legend







Display Icons

-  Sonde Frequency
-  Active Trace Frequency
-  Passive (AC) Trace Frequency
-  Sound Level
-  Battery Level
-  Depth
-  Horizontal Angle Indicator
-  Signal Strength
-  Tools Menu
-  LCD Contrast
-  LCD Backlight



Safety Alert Symbol, Refer to documentaion for safety messages

Keypad Icons

-  Menu Navigation
-  Audio Tone Reset/Menu Item Select
-  Menu Navigation/Forced Depth (3 sec. press)
-  Power ON/OFF Key
-  Menu Key
-  Sonde/Trace/Frequency Mode Key
-  Volume Control Key

What Is The Scout Advantage?

Scout Views all of the signal (electromagnetic fields) with multidirectional antenna. The multidirectional antenna offers definite advantages:

1. Signal always gets stronger as user gets closer to the target.
2. Eliminates Nulls and “Ghost Peaks”. With conventional locators it is possible to have signal strength go up as it is moved farther away from the target. A conventional locator signal has a peak then a null and then a smaller peak. This can confuse the operator especially if they interpret a smaller peak (known as “Ghost” or “False” peaks) as the target. The Scout sees just one peak to draw the user to the target.

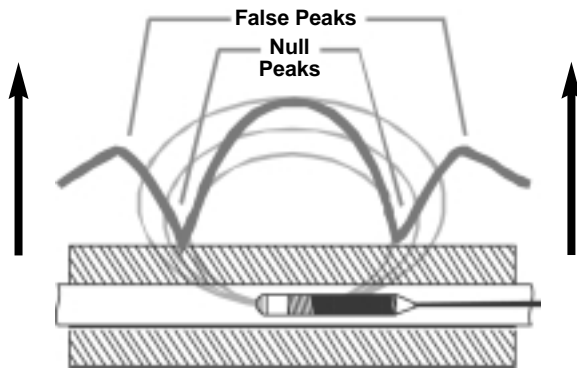

Figure 1 – Sonde signal as “seen” by a conventional locator. Main peak in center and two false peaks outside the two nulls.

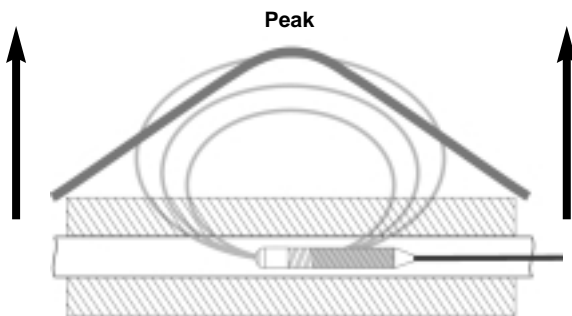

Figure 2 – Sonde signal as “seen” by the Scout. Only one peak, no nulls.

3. How the unit is held does not affect signal strength. The user can approach from any direction and does not need to know the lie of the pipe or wire.
4. Additional tools to identify and solve “difficult” locates include a graphical micro map and an angle indicator to help interpret signal characteristics.

What Is The Micro Map Advantage?

The map provides graphics that shows the signal’s characteristics. It is a bird’s eye view of the signal underground, shown graphically on the screen. It is used as a guide for tracing underground lines and can be used to better pinpoint sondes. It can also be used to provide more information for complex locates.

By moving the locator over the ground the Scout passes over the signal emitted by the underground objects. This allows the user to see on the screen, visualizations of the signal and then mark them. Conventional locators cannot map the underground signal as their antennas cannot see the complete shape of it.

Scout Components



Figure 3

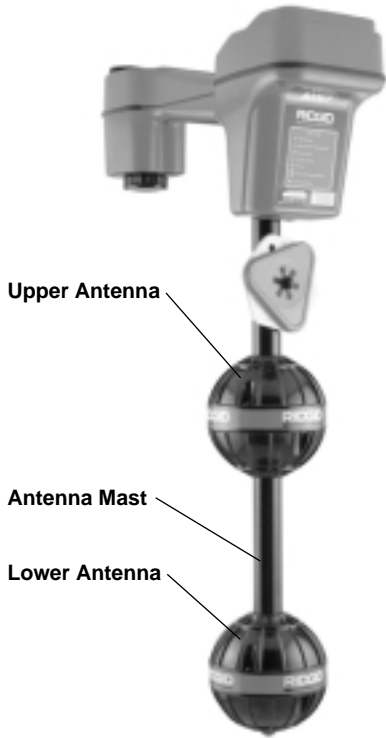

Figure 4

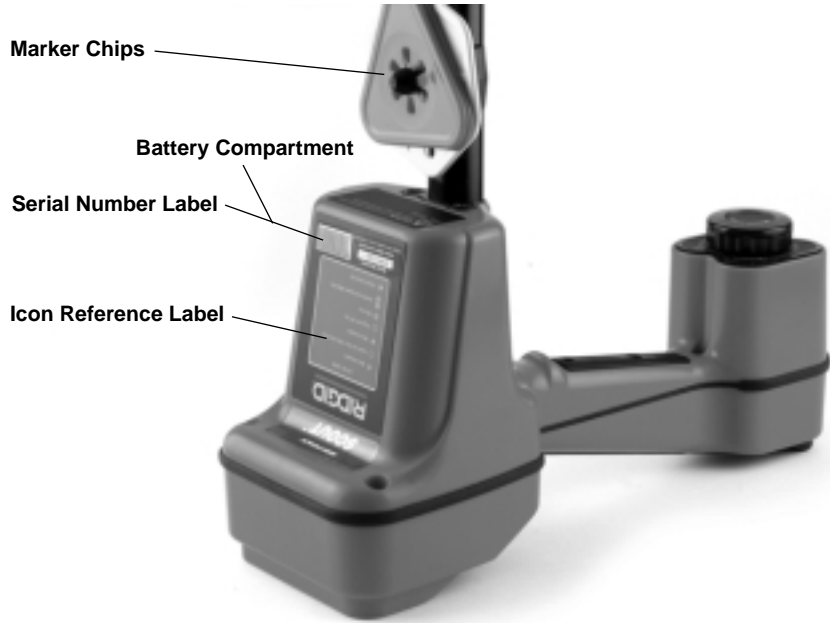

Figure 5

Display Screen



Figure 6

Keypad

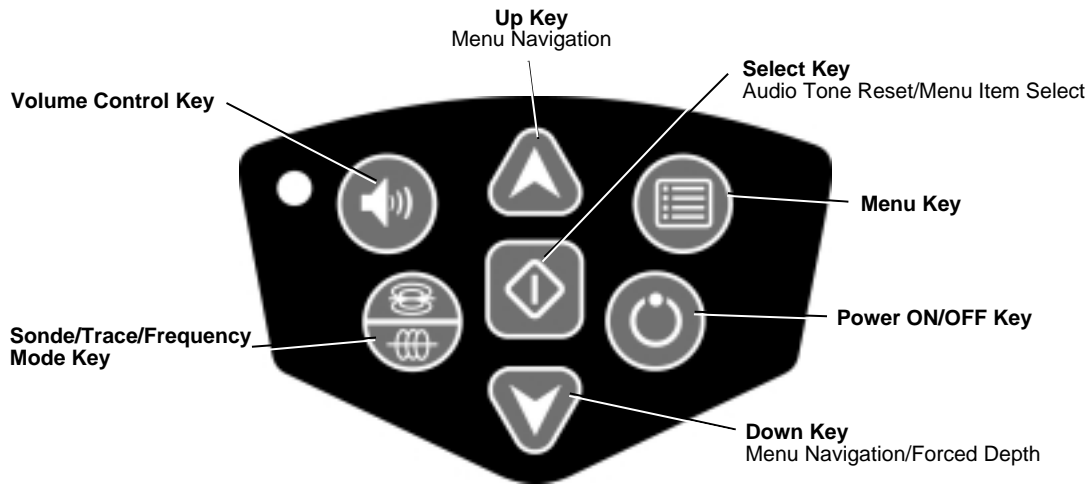

Figure 7

- Volume Control Key** — opens and closes the Sound Level menu
- Sonde/Trace/Frequency Mode Key** — switches active frequencies and functions.
- Up Key** — scrolls up through menu choices.
- Select Key** — selects the highlighted choice when a menu is open
- Down Key** — scrolls down through menu choices, hold down to force depth reading.
- Menu Key** — opens/closes the menu.
- Power ON/OFF Key** — turns the Scout ON or OFF.

Getting Started

Installing/Changing Batteries

To install batteries into the Scout turn the unit over to access the battery compartment. Turn the knob on the battery cover counter clockwise. Pull straight up on the knob to remove the door. Insert the batteries as shown on the inside decal and make sure they drop to full contact.

Fit the door into the case and turn the knob clockwise while lightly pressing down to close. The battery cover can be installed in either orientation.

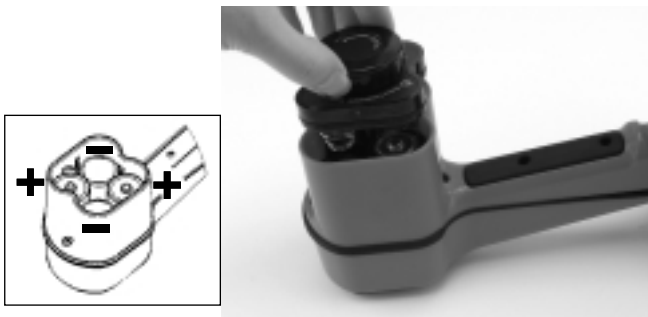

Figure 8

When the Scout is turned on it takes a few seconds to check the batteries. Until then the battery level will show as “empty”.

⚠ WARNING Do not allow debris to fall into battery compartment. Debris in the battery compartment may short the battery contacts, leading to rapid discharge of the batteries, which could result in electrolyte leakage or risk of fire.

Operation Time

Typical operation time for the Scout locator, when using alkaline cells, ranges from about 12 to 24 hours depending on factors such as sound volume, and how often the backlight is on. Other factors that affect the operation time will include chemistry of the battery (many of the new high performance batteries, such as the “Duracell® ULTRA” do last 10%-20% longer than conventional alkaline cells under high demand applications). Operation at low temperatures will also reduce battery life.

To preserve battery life the Scout will automatically shut down after 1 hour of no key presses. Simply turn the unit on to resume use.

Powering Up and Down

Turn the power ON by depressing the Power  key on the keypad. The RIDGID® logo displays, the software version number will appear in the lower right corner.

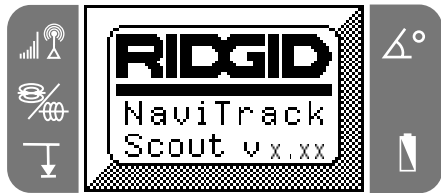



Figure 9

Turn the unit OFF by depressing and releasing the Power  key on the keypad.

Low Battery Warning

When the battery gets low, a battery icon will appear in the map area on the screen. This indicates that the batteries need to be changed and that the unit will soon shut down.

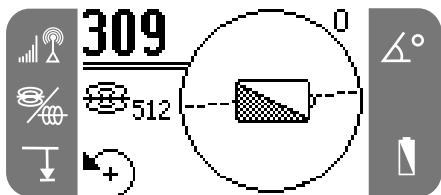

Figure 10

Just before complete shut down there will be a non-interruptible power down sequence.

In some cases the voltage on rechargeable batteries may drop so quickly that the unit will just shut down. The unit will turn OFF and restart. Just replace the batteries and turn the unit back ON.

Set Up

Once the Scout is up and running the next step is to set up the frequencies needed that match the equipment to be located. Each is activated for use by selecting them from a list in the menu.

1. Push the menu key:



Figure 11

- Using the up and down arrows highlight a frequency to match the one used in the sonde or on the line transmitter, then press the select key (*shown below*) to check the box. See the Menu Choices for reference. Hit the menu key again to return to the main screen.

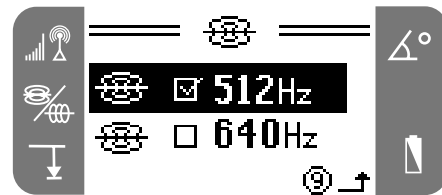

Figure 12

⚠ WARNING Be sure that the frequency selected matches the desired use. 512 and 33 are available as both sonde AND line trace frequencies. Using a sonde frequency for line tracing or vice versa, can cause the Scout to display incorrect depth information.

- Now press the sonde/trace/frequency mode  key to cycle through the activated frequencies and modes. Pay attention to the icons on the screen to see which mode the Scout is operating in.



Figure 13

4. If the depth, auto backlight or LCD contrast needs to be adjusted then highlight the selection in the tools section of the menu and make changes using the select key.

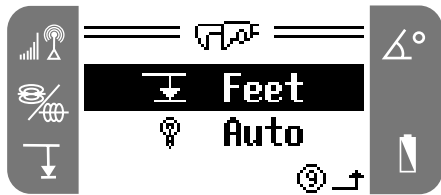

Figure 14

Menu Choices

Sonde Mode Frequencies		512 Hz 640 Hz 874 Hz 33 kHz
Line Trace Mode Frequencies		50 Hz (Passive) 60 Hz (Passive) 512 Hz 8 kHz 33 kHz
Tools Menu		Feet/Meters Auto Back Light LCD Contrast

Sounds of the Scout

The sound is related to the signal strength. The Scout's audio increases in pitch as signal strength ramps up, and decreases in pitch as signal strength ramps down.

The pitch will only increase as the signal strength goes up. When the signal strength decreases the audio pitch will decrease until it reaches the bottom of its tonal range. If signal strength continues to decrease, the audio will ramp downward to a base-warble tone until signal strength begins to increase again.

Adjust the sound by pressing the Sound Key.



Figure 15

The volume will step to a higher volume with each press of the sound key or the up and down arrows can be used to adjust the volume as well. Press the select key to exit this screen.

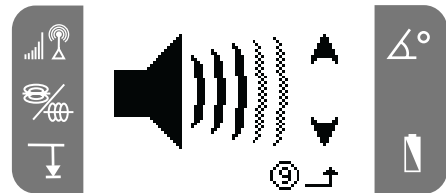

Figure 16

NOTE! Pressing the select key during normal operation will center the pitch to a medium level.

Tools Menu

Change of Depth Units

The Scout can change the units that it measures depth to either Feet or Meters. To change these settings simply highlight the depth icon in the Tools Menu and then press the select key to toggle between feet or meters.



Figure 17

Auto Back Light

Low light levels are sensed by a light detector built into the upper left corner of the keypad. The backlight can be forced on by blocking the light to this sensor with a thumb.

The automatic LCD backlight is factory set to only turn on under fairly dark conditions. This is to conserve bat-

tery power. As the batteries near depletion, the backlight will appear dim. Near the end of battery life, the backlight operates at a very low level to conserve battery power.

To set the backlight to always off, highlight the light bulb icon in the tools section of the menu and press the select key to toggle it between Auto and OFF.



Figure 18

LCD Contrast

When this is highlighted and selected the LCD contrast can be adjusted.



Figure 19

Use the up and down arrows to make the screen lighter or darker.

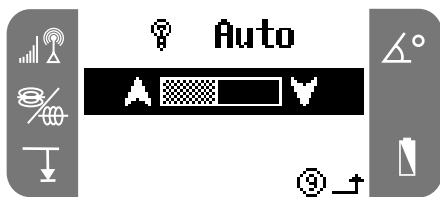

Figure 20

Locating the sonde

The Scout can be used to locate the signal of a sonde (transmitter) in a pipe, so that its location can be identified above ground. Sondes can be placed at a problem point in the pipe using a camera push rod or cable. They can also be flushed down the pipe.

The following assumes that the sonde is in a horizontal pipe, the ground is approximately level and the Scout is held with the antenna mast vertical.

IMPORTANT! Signal strength is the key factor in determining the sonde's location. To ensure an accurate locate, you **MUST** take care to maximize the signal strength prior to marking an area for excavation.

When locating a sonde set up the locate in the following manner:

- **Before** putting the sonde in the line, use the Scout to make sure it's operating and that Scout is receiving its signal.
- Once the sonde is in position and transmitting, activate the sonde and match the same frequency as the sonde on the Scout. Make sure it has a sonde mode icon.

⚠ WARNING Be sure that the frequency selected matches the desired use. 512 and 33 are available as both sonde AND line trace frequencies. Using a sonde frequency for line tracing or vice versa, can cause the Scout to display incorrect depth information.

- Go to the suspected sonde location. If the direction of the pipe is unknown, push the sonde a shorter distance into the line (~15 feet from the access, is a good starting point).

Next use one of the following methods to locate the sonde.

Method 1 – Maximize Signal Strength

1. Hold the Scout so the mast is out away from your body. Sweep the mast in the suspected direction of the sonde while observing the signal strength and listening to the sound. The signal will be highest when the mast is closest to the sonde.
2. Lower Scout to its normal operating position (mast vertical) and walk in the direction of the sonde. As you approach, the signal strength will increase and the audio tone will ramp and rise in pitch. Use the signal strength and the sound to maximize the signal.

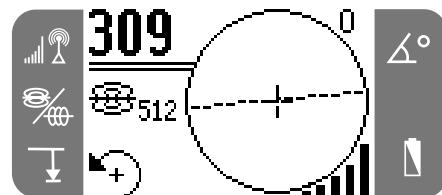

Figure 21

3. Once the maximum signal has been located, place the Scout close to the ground over the peak and move in all directions. Move the Scout away from the maximum signal strength, to make sure that the signal drops off on all sides.



Figure 22

Method 2 – Follow the Equator - Then Maximize

1. Works best in unobstructed, open areas, when the sonde is expected to be horizontal. Sweep the mast and then walk in the direction of maximum signal strength as in *Method 1*.
2. When the Scout displays a steady Equator line, center it on the screen and then follow it towards increasing signal strength. When maximum has been located, place the Scout close to the ground over the peak and move in **all** directions. Move the Scout away from the maximum signal strength, to make sure that the signal drops off on all sides.



Figure 23

Verify the Locate

1. At the point of maximum signal strength, and with the mast vertical, move the Scout perpendicular to the Equator line on the screen. When the Pole icon appears, move Scout until the Pole icon is centered on the crosshairs with the lower antenna ball on the ground. Place one of the red triangle markers on the ground at this spot.

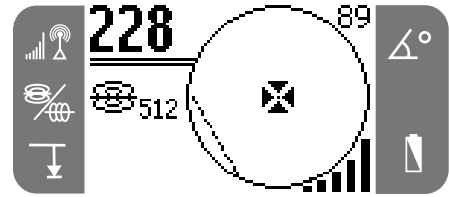

Figure 24 – View when Scout is on the pole.

2. Move Scout back across the Equator line to the other pole. Center the crosshairs on the second Pole icon and mark its position as before.
3. Move back to the point of **maximum signal strength**. Mark this point on the ground with the yellow hexagon marker chip. Move the lower antenna ball slowly away from the yellow marker in all directions while observing the signal strength display. The signal strength should be highest directly over the sonde.
4. Look to see that all three markers are aligned and that the yellow hexagon marker is approximately half way between the Pole markers.

If the yellow marker is not in the middle, see the section on tilted sondes.

IMPORTANT! Being on the Equator does NOT mean you're over the sonde! Remember that signal strength is the key factor in locating the sonde. You must be at the point of highest signal strength AND be on the Equator (dashed line).

For best accuracy use the bubble level. The mast MUST be vertical when marking the Poles and Equator, or their locations will be less accurate!

Measuring Depth

The Scout measures depth by comparing the strength of the signal at the lower antenna to the upper antenna.

Depth is measured when the bottom antenna is touching the ground directly above the signal source.

1. To measure depth place the locator on the ground, directly above the sonde or line. Make sure that the angle indicator reads 5 degrees or less. Then slowly rotate the unit in the direction of the arrow shown on the **bottom left** of the screen until the depth appears.

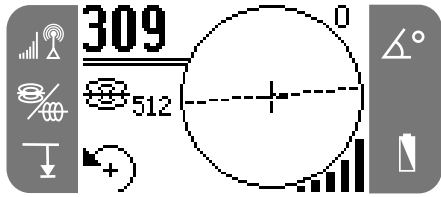

Figure 25

The bubble level is useful when measuring depth to make sure that the antenna mast is vertical.

In order to maximize signal and achieve a more accurate depth reading, the Scout needs to be rotated to align the upper antenna with the signal.

2. Depth will be shown in the lower left hand corner.
3. **Force Depth Feature** – If the angle indicator reads higher than 5 degrees then the Scout will not give a depth measurement. Press the down arrow key and hold it. This will force the depth to display if depth can be measured. (See the following section on tilted sondes.)

⚠ WARNING Using the force depth feature can provide inaccurate depth measurements.

When checking the depth **always** take a measurement, then rotate the Scout 180 degrees (1/2 circle) and take another depth measurement. Be sure that the lower ball stays at the same position on the ground and the mast is vertical. **If the depth readings are not within about 10% of each other then distortion is present and the depth reading should be questioned.**

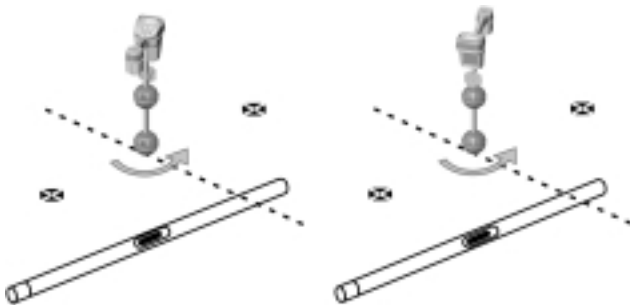

Figure 26

Operating Tips for Locating a Sonde

- Use the sound when possible to help guide the Scout to the maximum signal strength.
- If the Equator is crossed, and the signal is not maximized, follow the Equator to the highest signal strength. Simply finding the Equator of the sonde (the dashed line on the screen) does **NOT** indicate that the sonde has been found. **The point of maximum signal strength** along this line must **also** be found. Generally following the Equator line will lead the operator to the “vicinity” of the sonde. If the sonde is steeply tilted, the Equator will **NOT** lie directly above the sonde and the distance from the sonde to each Pole will not be equal. If the sonde is tilted, maximize the signal.
- Always confirm the point of maximum signal strength. Verify what the map is showing. The map assumes the following conditions:
 1. The ground is level
 2. The sonde is level
 3. The Scout Locator is above ground level
 4. The Scout Locator is held approximately vertical, antenna mast pointing straight down.

If these conditions are not met, pay close attention to maximizing signal strength. In general, if the above conditions are true and if the Scout is within about two “depths” of the signal source, the map will be useful and accurate. Be aware of this when using the map if the target or signal source, is very shallow. The useful search area using the map alone can be small if the sonde is extremely shallow.

Micro Map – Examples – Sonde Mode

Scout on the Equator

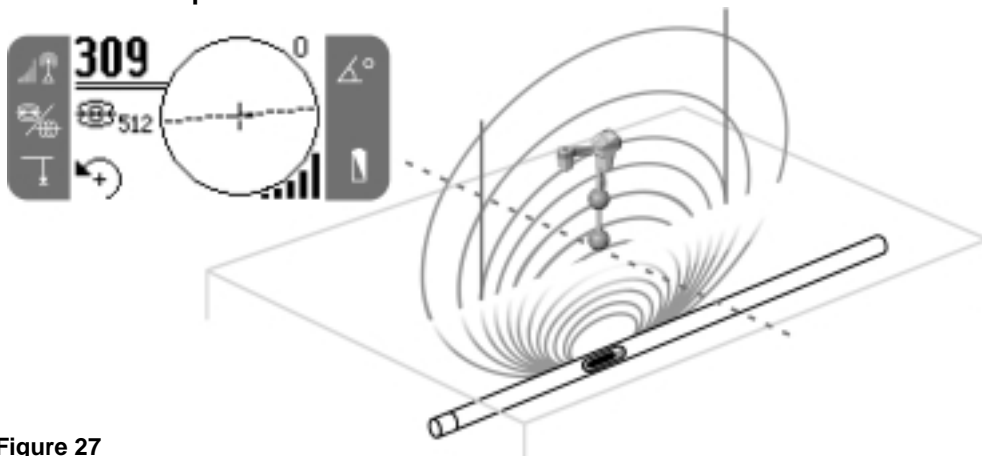

Figure 27

Scout leaves the Equator and approaches the Pole

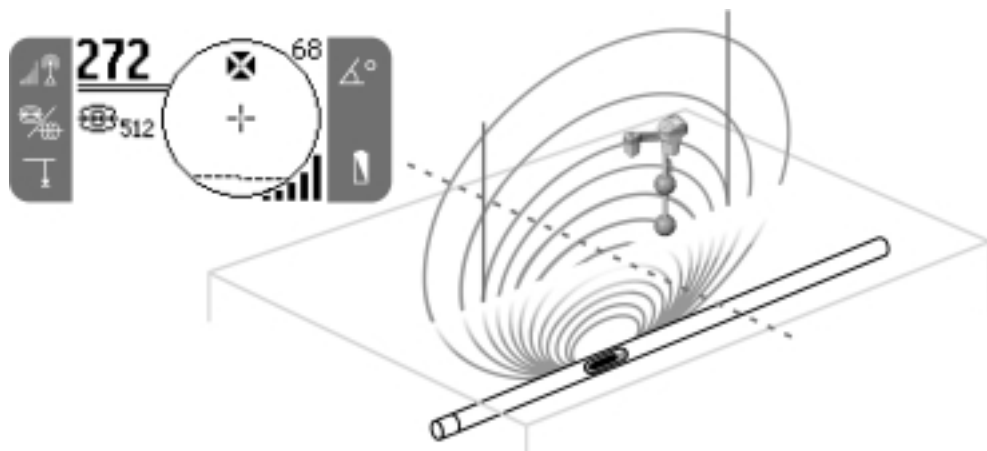

Figure 28

Scout on the Pole

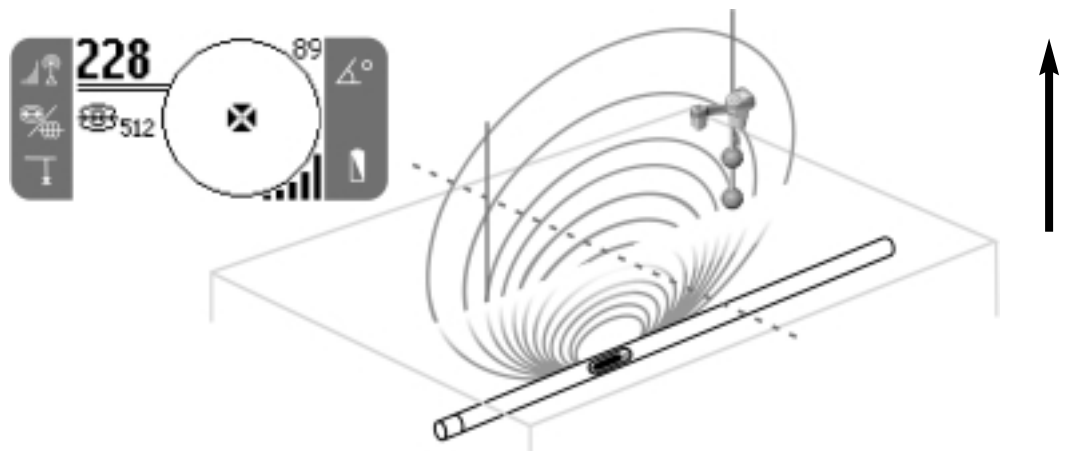

Figure 29

Tilted Sondes

If the sonde is tilted, one Pole will move closer to the sonde and the other farther away so that the sonde location no longer lies midway between the two poles. The signal strength of the nearer Pole becomes much higher than that of the more distant Pole. In the extreme as the sonde tilts to vertical, the one Pole moves to a point directly above the sonde and this Pole will also correspond to the point of maximum signal strength. The other Pole will not be seen. Therefore even if the sonde is vertical, as it could be if it fell into a break in the line or an underground tank, the sonde can still be located.

What is seen on the screen is a Pole of maximum signal strength when the sonde is vertical.

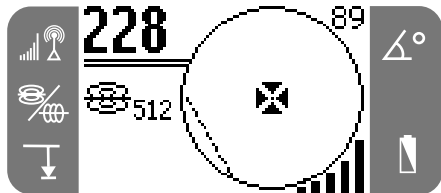

Figure 30

The multi directional antennas allow the depth to be measured even if the sonde is tilted. In this circumstance the force depth feature must be used to take a depth measurement. (See *Measuring Depth.*)

Tracing a Line with Scout

The Scout can also be used to trace a pipe or line so that the ground above it can be marked. This identifies the line's location so that it can be avoided during a dig or exposed for repair or replacement. The Scout can locate energized lines with a variety of frequencies or it can be used passively to conduct a sweep to locate any long conductors carrying signals.

Underground lines are energized with a line transmitter. This active signal is then traced using a receiver such as the Scout.

1. Attach the line transmitter to the line according to the manufacturer's instructions.

A "transmitter" is a generic name used for anything that generates a locatable signal. It is used to describe a sonde as well as the device that is used to energize a cable or pipe.

2. Match the frequency used on the transmitter with the same frequency on the Scout. Be sure it has a line trace icon . Push the main menu button to return to the locate screen.



Figure 31

3. When beginning the trace it is recommended that signal strength be observed first to see if it drops when the Scout is pulled away. Point the mast at the leads or the transmitter itself if using inductive mode. It should peak and drop off on either side.
4. When tracing, the way the pipe or cable is running will be shown on the screen with 2 solid lines. Keeping the lines on the center indicates that the Scout is tracing the line underground. If the line moves off to the left or right then move the Scout to get the line back on center. An undistorted signal emitted from a line is strongest directly over that line.

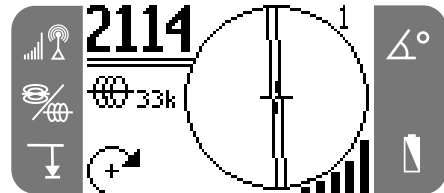



Figure 32

NOTE! When using a line trace frequency there are two lines on the screen. When using a sonde frequency, the Equator is a single line.

CAUTION Care should be taken to watch for signal interference that may give inaccurate readings. Depth readings should be taken as estimates and actual depths should be verified by exposing the line before digging.

Tracing a Passive AC Line

In passive mode the Scout senses alternating current, or AC fields. Buried power lines typically do not emit any traceable signal unless power is flowing in the wires. For example street lights that are turned off are hard to trace passively.

1. Select a Passive AC Trace Frequency with the passive line trace icon. 
2. The Scout has two (2) passive AC tracing frequencies that are standard. They are 50Hz and 60Hz.

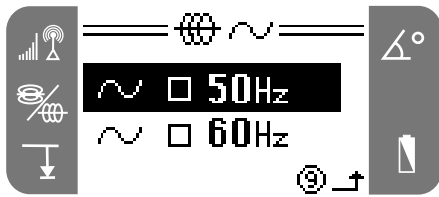

Figure 33

Operating Tips for Line Tracing

- **When the lines are not centered on the map, but signal strength is maximized, distortion is present!**
 - a) Try changing to a lower frequency.
 - b) Move the ground stake position away from the line to be traced.
 - c) Make sure that the line is not commonly bonded to another utility.
- If the lines will not center or if they move across the screen inexplicably, then the Scout may not be receiving a clear signal.
 - a) Check the transmitter to be sure that it is operating and well grounded.
 - b) Test the circuit by pointing the lower antenna at either transmitter lead.
 - c) Check that the Scout and transmitter are operating on the same frequency.
 - d) Try different frequencies, starting with the lowest, until the line can be picked up dependably.
- While tracing, the signal should maximize, and the depth minimize, at the same place where the lines centers on the display. If this is not the case, the utility may be turning or other coupled signals may be present.

- Higher frequencies bleed over more but may be needed to jump breaks in tracer wires or go over insulating couplers.
- When using the transmitter inductively, be sure to begin the locate 40 to 50 ft away to avoid “direct coupling”. This is where the Scout will pick up the signal from the transmitter directly and not from the line to be traced.

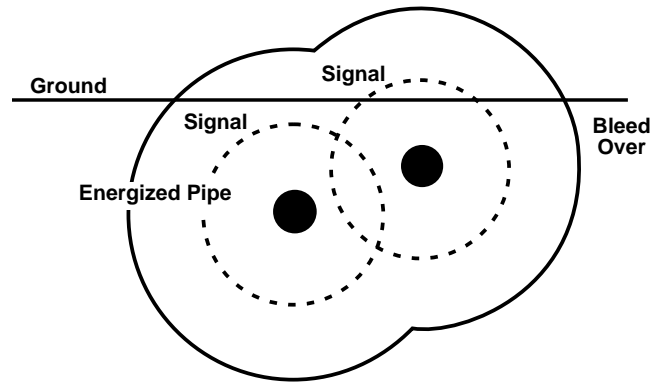

Figure 34

While Tracing the micro map assumes the following conditions:

- a) The Ground is level
 - b) The Line is level
 - c) The Scout Locator is above ground level
 - d) The Scout antenna mast is held approximately vertical
- If these conditions are not met, pay close attention to maximizing signal strength. In general, if the Scout is within about two “depths” of the line, the map will be useful and accurate. Be aware of this when using the micro map if the target or line is very shallow. The useful search area in Micro map can be small if the line is extremely shallow.

Micro Map – Example – Line Trace

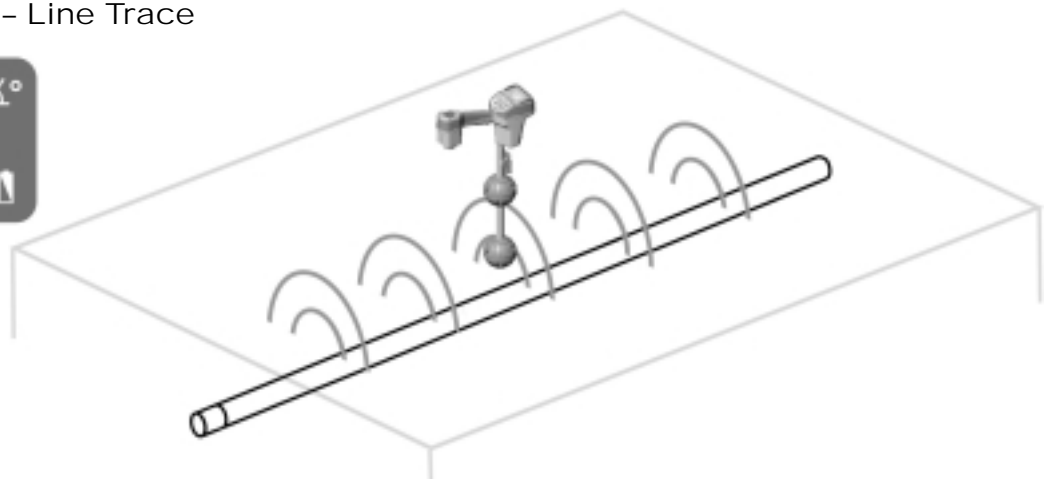

Figure 35

Notes On Accuracy

Noise

Interfering signals (noise) are simply part of the locating challenge. Interference can either be at the same frequency being used, or it can be “out of band” at other frequencies. Some of the largest interfering signals are generated by power transmission equipment. Power transformers, large electric motors or generators and lines can be the source of very large noise signals. Areas that are particularly noisy should be avoided if that is possible.

If the angle display is unstable and not steady, and/or if the signal levels are not steady, this is a good indication of either no target signal present (sonde or energized line), or a high level of interfering noise.

Locating Is Not An Exact Science

Locating is not an exact science. It does require the operator to use judgement and look for all the information available beyond what the instrument readings may be. The Scout will give the user more information but it is up to the operator to interpret that information correctly. No locator manufacturer will claim that an operator should follow the information from their instrument exclusively.

Conditions when locating accuracy must be questioned:

- **When other lines or utilities are present.** “Bleed over” may produce distorted fields and illuminate lines unintentionally. Use lower frequencies when possible and eliminate all connections between the two lines.

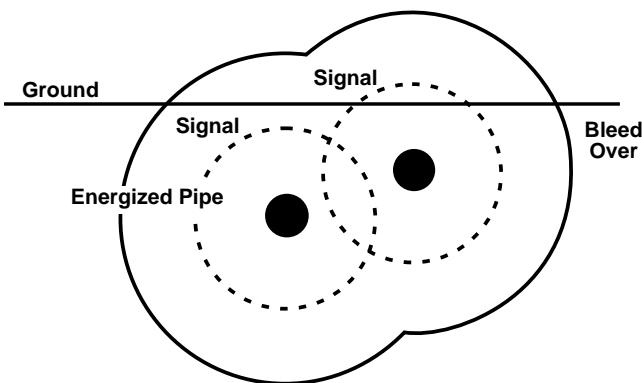

Figure 36

- **When using the transmitter inductively.** This gives the line a weak signal. Use a direct connection whenever possible.
- **When Ts or splits are present in the line.** Can cause distortions in the signal.

- **When signal strength is low.** A strong signal is necessary for accurate locating.
- **When soil conditions vary.** Extremes in moisture, either too dry or overly saturated, may affect measurements. For example ground that is saturated with salty water, that might be found by the coasts, will shield the signal severely and be very difficult to locate in.

Locating Faulty Components

For troubleshooting suggestions, please refer to the *Troubleshooting Guide* at the end of the manual. If necessary, contact Ridge Tool Technical Service at 800-519-3456. We will establish a plan of action to get your Scout working for you.

Service and Repair



Tool should be taken to a RIDGID Independent Authorized Service Center or returned to the factory. All repairs made by Ridge service facilities are warranted against defects in material and workmanship.

If you have any questions regarding the service or repair of this machine, call or write to:

Ridge Tool Company
 Technical Service Department
 400 Clark Street
 Elyria, Ohio 44035-6001
 Tel: (800) 519-3456
 E-mail: TechServices@ridgid.com

For name and address of your nearest Independent Authorized Service Center, contact the Ridge Tool Company at (800) 519-3456 or <http://www.ridgid.com>

Chart 1 Troubleshooting

PROBLEM	PROBABLE FAULT LOCATION
Scout locks up during use.	Turn the unit OFF, then back ON. Remove the batteries if the unit will not turn OFF.
While tracing, lines are “jumping” all over the screen in micro map.	<p>This indicates that the Scout is not picking up the signal or there is interference.</p> <p>Make sure that the transmitter is well connected and grounded. Point the Scout at either lead to be sure that you have a complete circuit.</p> <p>Try a higher frequency.</p> <p>Try to determine the source of any noise and eliminate it.</p>
While locating a sonde, lines are “jumping” all over the screen.	<p>Check the batteries in the sonde to see that they are working.</p> <p>Verify signal by placing lower antenna close to sonde. Note - Sondes have difficulty emitting signals through cast iron and ductile iron lines.</p>
Distance between sonde and either Pole is not equal.	Sonde may be tilted or there may be a cast iron to plastic transition.
Unit acts erratic, won't power down.	Batteries may be low. Replace with fresh batteries and turn ON.
Display appears completely dark, or completely light when it is turned ON.	<p>Try Powering the unit OFF and then back ON.</p> <p>Adjust the LCD screen contrast.</p>
There is no sound.	Adjust the sound level in the sound menu.
Scout will not pick up the signal.	Check that the correct mode and frequency is set.
Scout will not turn on.	<p>Check orientation of batteries.</p> <p>Check that the batteries are charged.</p> <p>Check to see that the battery contacts are OK.</p> <p>Unit may have blown a fuse. (Factory service is required.)</p>
Depth appears inaccurate.	Check locate mode. Example: if locating a line  in 512Hz make sure not in Sonde  Mode. (Check if in heavily distorted environment.)

Appendix A Understanding Sondes and The Scout

Electrical fields emitted by buried objects can be of two types; the first type, is emitted by long conductors such as energized wires, inspection camera push cables or pipes. These objects produce a long cylindrical field and this is often referred to as “Line” tracing.

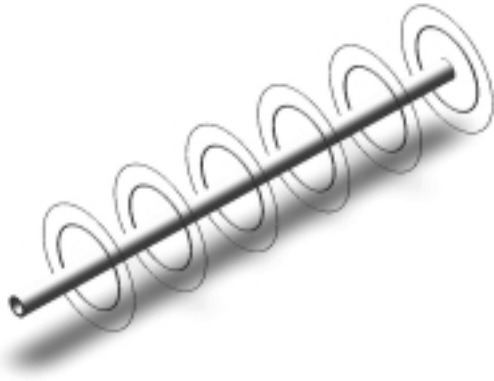

Figure 1 – The field emitted by a charged line.

(Passive, AC Tracing is just a special case where the line is “energized” with electrical power.)

The second type, sondes, (also called transmitters, beacons, or active duct probes) emit a differently shaped field and the Scout is programmed to measure and display this type of field. The more complex field shape of a sonde, is called a *dipole field*, and is the same as that produced by a bar magnet and our planet Earth.

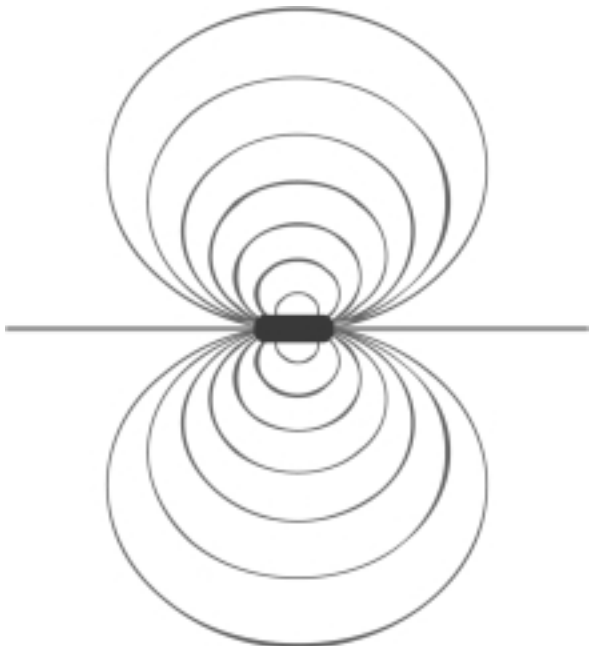

Figure 2 – The dipole field emitted by a sonde.

In fact, if the Earth were turned on its side, its magnetic field would look a lot like the field from a sonde.

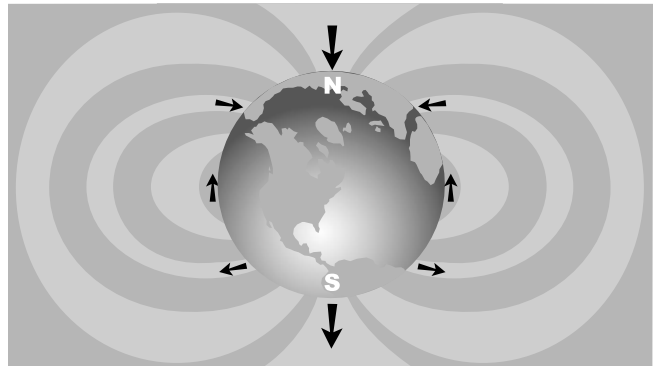

Figure 3

As a locator, the Scout can measure the shape (angle) of the field lines from a sonde and identify distinct characteristics of these lines. Three important characteristics are the two **POLES** and the **EQUATOR**. At the Poles the angle of the signal is 90 degrees (vertical). At the Equator it is 0 (horizontal). Poles are distinct points in space, while the Equator wraps completely around the sonde. Since these distinct characteristics are constant, they can be used to accurately pinpoint the location of the sonde.

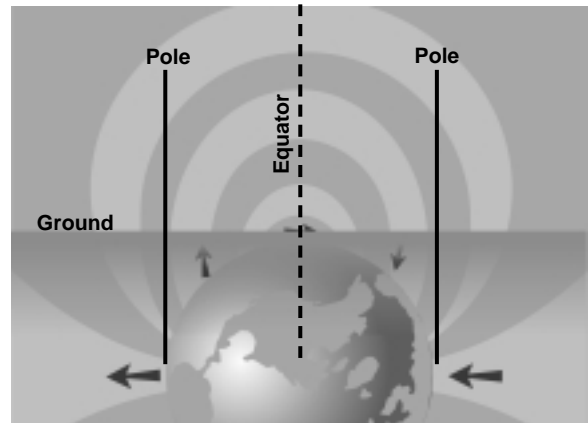

Figure 4

Poles usually occur where conventional locators would experience “nulls”, the dead spots that occur when the signal passes through their antennas vertically. The difference is that Scout can “see” the Poles (“nulls”) and show you where they are, **even when you’re not directly over them, and no matter how Scout’s antennas are aligned with the signal**. This is one reason why locating with Scout is so much easier than with conventional locators.

If vertical the sonde is located at the point where the Equator passes directly between the two Poles.

Electromagnetic fields have three (3) important properties, frequency, strength and angle (direction). Unlike conventional locators, which can only measure strength in the direction of the individual antenna(s), the Scout measures both signal strength and field angles in three dimensions (3D). This enhanced capability makes the mapping display possible. The experienced operator can use this additional information to speed the locating process and to help sort out complex locating situations. On the other hand, the occasional or novice user, can easily locate using signal strength alone.

The Scout locating rule #1 is make the number big! — Maximizing signal strength is the key, primary locating method.

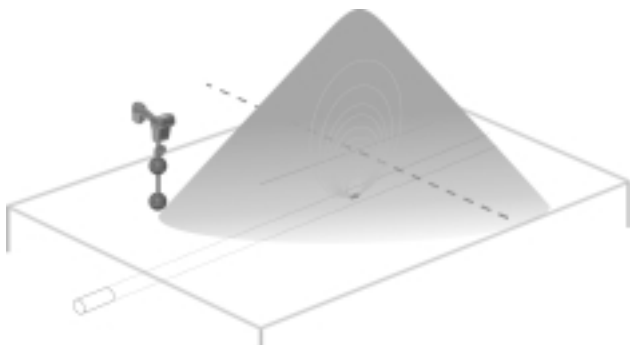

Figure 5 – Example of how the Scout maximizes directly over the sonde.

Whether line tracing or locating a sonde, maximum signal strength occurs over the target. Depth is displayed when over the target.

Appendix B

Other Useful Information

Signal Interference

Distorted Fields

Sometimes a single field may encounter metal or other ferrous material in the ground that may distort the field lines. It may be another utility, buried scrap or old unused lines that can shunt or shorten the field lines. In this case the Scout may display a weaker signal around the object and a stronger signal directly above it. The object may act as a lens that amplifies or weakens signal unpredictably.



Figure 1

Composite Fields

Composite fields are also possible. Where a single field meets another, the two, or more, may create a stronger signal. It is important for operators to understand this around “Ts” or right angles in the line, where composite fields are often encountered.

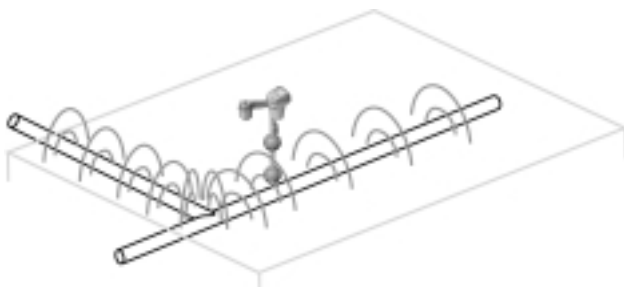

Figure 2 – Composite field shown around a connection in the line.

**What is covered**

RIDGID® tools are warranted to be free of defects in workmanship and material.

How long coverage lasts

This warranty lasts for the lifetime of the RIDGID® tool. Warranty coverage ends when the product becomes unusable for reasons other than defects in workmanship or material.

How you can get service

To obtain the benefit of this warranty, deliver via prepaid transportation the complete product to RIDGE TOOL COMPANY, Elyria, Ohio, or any authorized RIDGID® INDEPENDENT SERVICE CENTER. Pipe wrenches and other hand tools should be returned to the place of purchase.

What we will do to correct problems

Warranted products will be repaired or replaced, at RIDGE TOOL'S option, and returned at no charge; or, if after three attempts to repair or replace during the warranty period the product is still defective, you can elect to receive a full refund of your purchase price.

What is not covered

Failures due to misuse, abuse or normal wear and tear are not covered by this warranty. RIDGE TOOL shall not be responsible for any incidental or consequential damages.

How local law relates to the warranty

Some states do not allow the exclusion or limitation of incidental or consequential damages, so the above limitation or exclusion may not apply to you. This warranty gives you specific rights, and you may also have other rights, which vary, from state to state, province to province, or country to country.

No other express warranty applies

This FULL LIFETIME WARRANTY is the sole and exclusive warranty for RIDGID® products. No employee, agent, dealer, or other person is authorized to alter this warranty or make any other warranty on behalf of the RIDGE TOOL COMPANY.

**Ce qui est couvert**

Les outils RIDGE® sont garantis contre tous vices de matériaux et de main d'oeuvre.

Durée de couverture

Cette garantie est applicable durant la vie entière de l'outil RIDGE®. La couverture cesse dès lors que le produit devient inutilisable pour raisons autres que des vices de matériaux ou de main d'oeuvre.

Pour invoquer la garantie

Pour toutes réparations au titre de la garantie, il convient d'expédier le produit complet en port payé à la RIDGE TOOL COMPANY, Elyria, Ohio, ou bien le remettre à un réparateur RIDGID® agréé. Les clés à pipe et autres outils à main doivent être ramenés au lieu d'achat.

Ce que nous ferons pour résoudre le problème

Les produits sous garantie seront à la discrétion de RIDGE TOOL, soit réparés ou remplacés, puis réexpédiés gratuitement ; ou si, après trois tentatives de réparation ou de remplacement durant la période de validité de la garantie le produit s'avère toujours défectueux, vous aurez l'option de demander le remboursement intégral de son prix d'achat.

Ce qui n'est pas couvert

Les défaillances dues au mauvais emploi, à l'abus ou à l'usure normale ne sont pas couvertes par cette garantie. RIDGE TOOL ne sera tenue responsable d'aucuns dommages directs ou indirects.

L'influence de la législation locale sur la garantie

Puisque certaines législations locales interdisent l'exclusion des dommages directs ou indirects, il se peut que la limitation ou exclusion ci-dessus ne vous soit pas applicable. Cette garantie vous donne des droits spécifiques qui peuvent être éventuellement complétés par d'autres droits prévus par votre législation locale.

Il n'existe aucune autre garantie expresse

Cette GARANTIE PERPETUELLE INTEGRALE est la seule et unique garantie couvrant les produits RIDGID®. Aucun employé, agent, distributeur ou tiers n'est autorisé à modifier cette garantie ou à offrir une garantie supplémentaire au nom de la RIDGE TOOL COMPANY.

Ridge Tool Company
400 Clark Street
Elyria, Ohio 44035-6001

**Qué cubre**

Las herramientas RIDGID están garantizadas contra defectos de la mano de obra y de los materiales empleados en su fabricación.

Duración de la cobertura

Esta garantía cubre a la herramienta RIDGID durante toda su vida útil. La cobertura de la garantía caduca cuando el producto se torna inservible por razones distintas a las de defectos en la mano de obra o en los materiales.

Cómo obtener servicio

Para obtener los beneficios de esta garantía, envíe mediante porte pagado, la totalidad del producto a RIDGE TOOL COMPANY, en Elyria, Ohio, o a cualquier Servicentro Independiente RIDGID. Las llaves para tubos y demás herramientas de mano deben devolverse a la tienda donde se adquirieron.

Lo que hacemos para corregir el problema

El producto bajo garantía será reparado o reemplazado por otro, a discreción de RIDGE TOOL, y devuelto sin costo; o, si aún resulta defectuoso después de haber sido reparado o sustituido tres veces durante el periodo de su garantía, Ud. puede optar por recibir un reembolso por el valor total de su compra.

Lo que no está cubierto

Esta garantía no cubre fallas debido al mal uso, abuso o desgaste normal. RIDGE TOOL no se hace responsable de daño incidental o consiguiente alguno.

Relación entre la garantía y las leyes locales

Algunos estados de los EE.UU. no permiten la exclusión o restricción referente a daños incidentales o consiguientes. Por lo tanto, puede que la limitación o restricción mencionada anteriormente no rija para Ud. Esta garantía le otorga derechos específicos, y puede que, además, Ud tenga otros derechos, los cuales varían de estado a estado, provincia a provincia o país a país.

No rige ninguna otra garantía expresa

Esta GARANTIA VITALICIA es la única y exclusiva garantía para los productos RIDGID. Ningún empleado, agente, distribuidor u otra persona está autorizado para modificar esta garantía u ofrecer cualquier otra garantía en nombre de RIDGE TOOL COMPANY.

